

AKVWL6: WALL LOUVER, VENTILATION, 6"

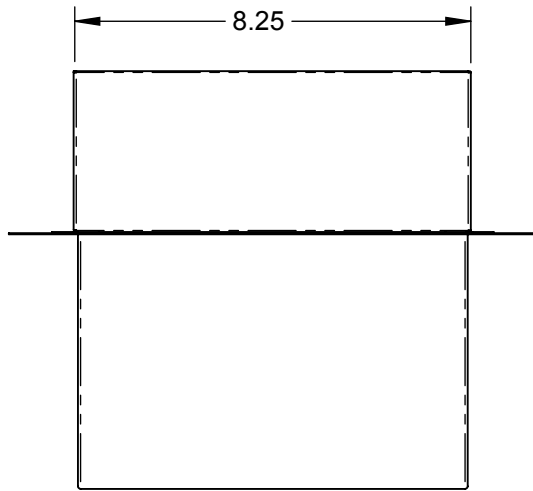

TOP VIEW

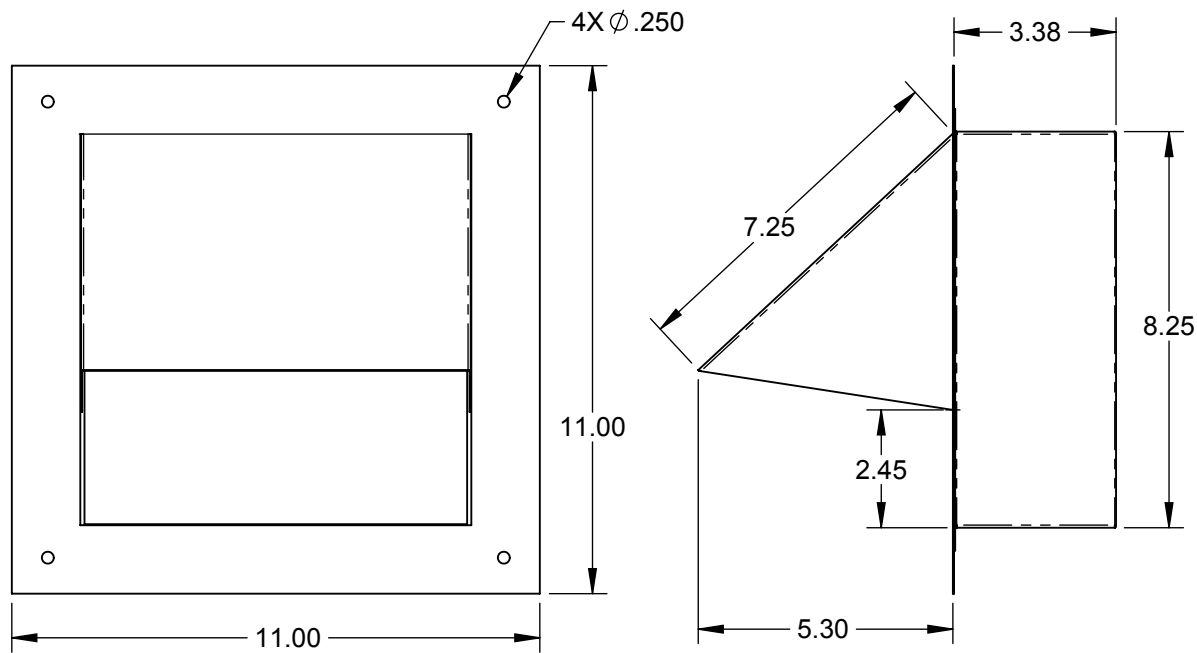
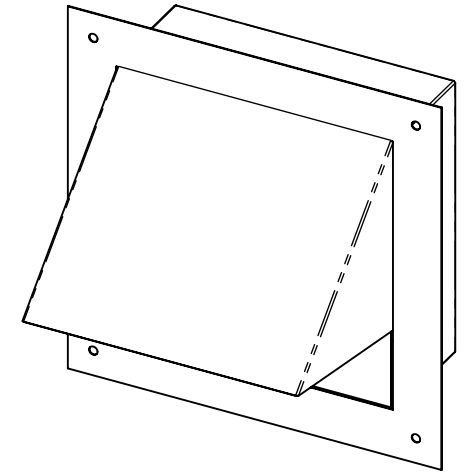

Ø6" HOLE
FOR ROUND
DUCT

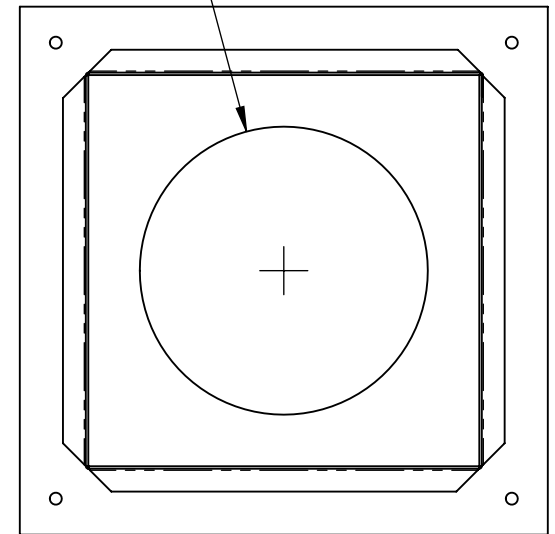

REAR VIEW