

KVDC1812: DUCT COVER, VENTILATION, 18W X 12H

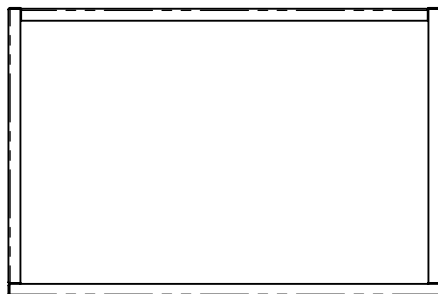

TOP VIEW

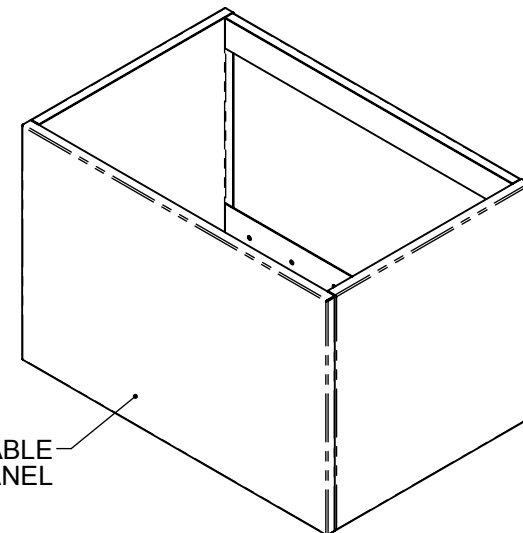

REMOVABLE FRONT PANEL

