

KVL30: 30" VENTILATION HOOD, LINER, 600 CFM

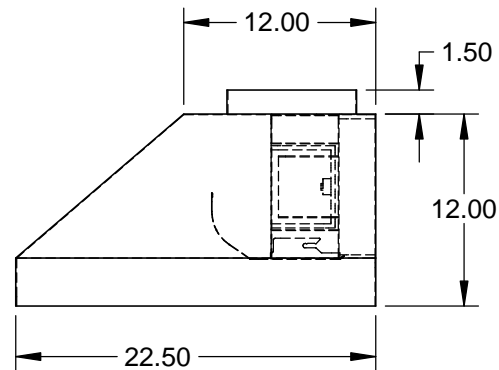
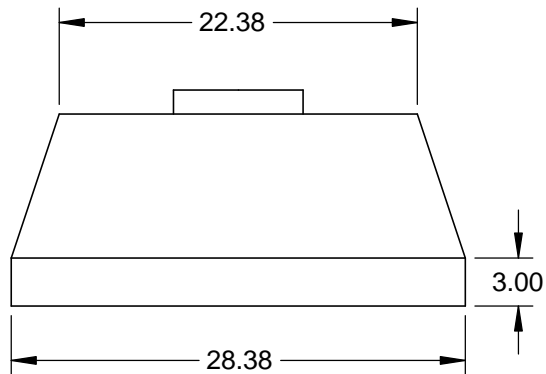
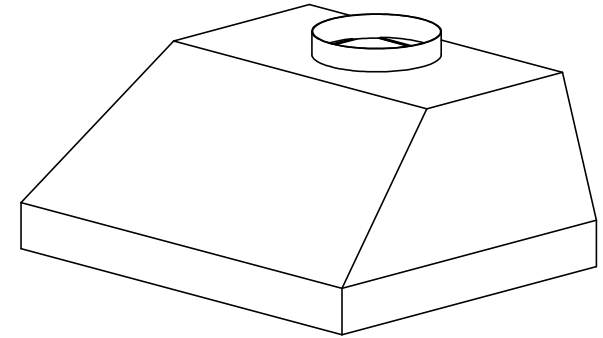
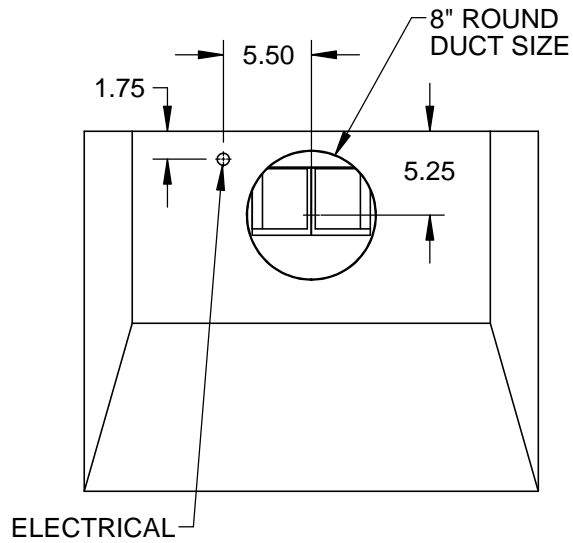

SPECIFICATIONS:

WEIGHT: 40 LBS.
VOLTAGE: 120V - 60Hz
CURRENT: 4.0A
CFM (EQUIV. CFM): 600 (900)
NOISE: 6.5 Sones
OF LIGHTS: 2