

KVL48: 48" VENTILATION HOOD, LINER, 900 CFM

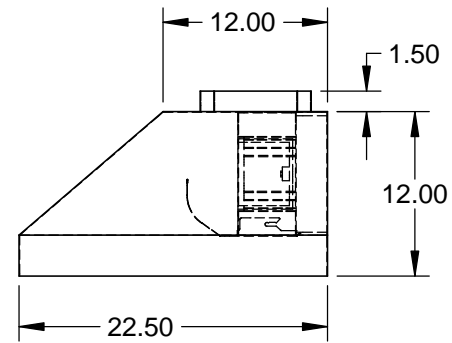
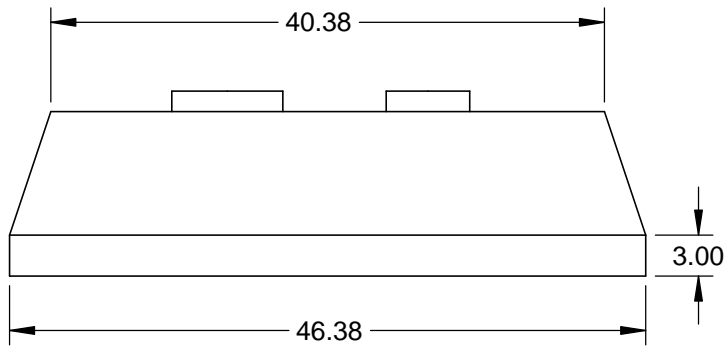
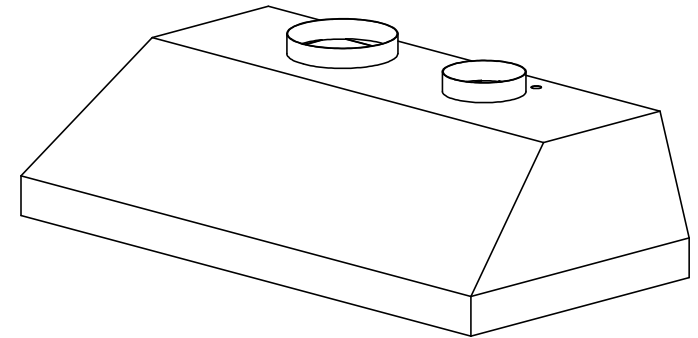
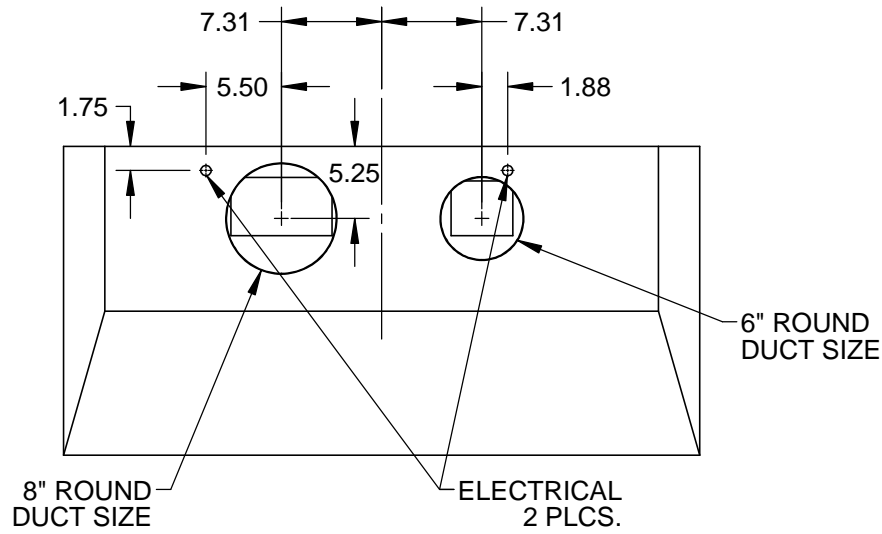

SPECIFICATIONS:

WEIGHT: 60 LBS.
VOLTAGE: 120V - 60Hz
CURRENT: 6.0A
CFM (EQUIV. CFM): 900 (1350)
NOISE: 6.3 Sones
OF LIGHTS: 3